

Set Top Box USER MANUAL



Set Top Box USER MANUAL

Dear Subscriber,

Congratulations for choosing the digital service from IN Digital. Now, you can take total control of your entertainment and avail of the best that digital television has to offer.

In our continuing commitment to you, our valuable subscriber, we present the digital Set Top Box (STB) - your gateway to a whole new world of high quality pictures and sounds on your television. The STB also comes with an in-built electronic program guide and an all-new remote control to make for the best possible viewing experience.

The IN Digital service brings to you everything from program schedules /synopsis to 24/7 customer support at your fingertips.

To further your advantage of the digital platform, we will be offering more value-added services like Pay-Per-View, Near Video On Demand, increased interactivity and more in the near future.

Welcome to the digital experience
Welcome to IN Digital



<http://www.indigital.co.in>

Set Top Box USER MANUAL

TABLE OF CONTENTS

Your STB Details

Technical Specifications

Your Remote Control

STB View

Getting Started

Tuning Channels & using On Screen Menu

Troubleshooting

Do's & Don'ts

Care & Maintenance

Set Top Box USER MANUAL

Your STB DETAILS

Digital Video Broadcast (DVB) Cable Standard ETS 300429 compliant Digital Set Top Box designed by Technotrend AG, Germany

Model IRD C2802-NG
with Embedded Conditional Access System (CAS) Nagravision



The package consists of

- Digital Set-Top-Box unit.
- External Power Supply Adaptor, 90-270 Volts A/C input and +12 Volts D/C output, Typical Power Consumption 10 Watts.
- Radio Frequency (R/F) Cable IEC Male to IEC Female connector type of 1.5 meters length.
- Audio / Video Cable with 3 RCA jacks (1 Video and two Audio left and right channel) on both the ends of 1.5 meters length.
- Remote Control unit with 2 X 'AA' type batteries.
- User Manual in English.
- Outer Plastic Retail Box.

Set Top Box USER MANUAL

TECHNICAL SPECIFICATIONS

- Based on Texas Instruments designed chipset.
- 4 MB Flash ROM, 8 MB EDO DRAM, 8 MB SDRAM Memory.
- Embedded Conditional Access System (CAS) Nagravision.
- Software Update of CAS over the DVB Cable Network.
- Smart Card Interface that is active and powered up in Standby mode.
- Radio Frequency Range 47 to 862 MHz for both VHF and UHF.
- QAM 16 / 32 / 64 / 128 / 256 demodulation support (ETS 300429).
- Symbol Rate of 1.7 to 7 M Symbols/sec.
- VHF / UHF support: upto 300 MHz PAL-B, 7 MHz bandwidth and above 300 Mhz PAL-G, 8 MHz bandwidth.
- Input and Output termination resistance 75 Ohms each.
- Supports both PAY and Digital Free-To-Air i.e. FTA channels.
- Advanced Electronic Program Guide, Parental lock & finger printing support.

Set Top Box USER MANUAL

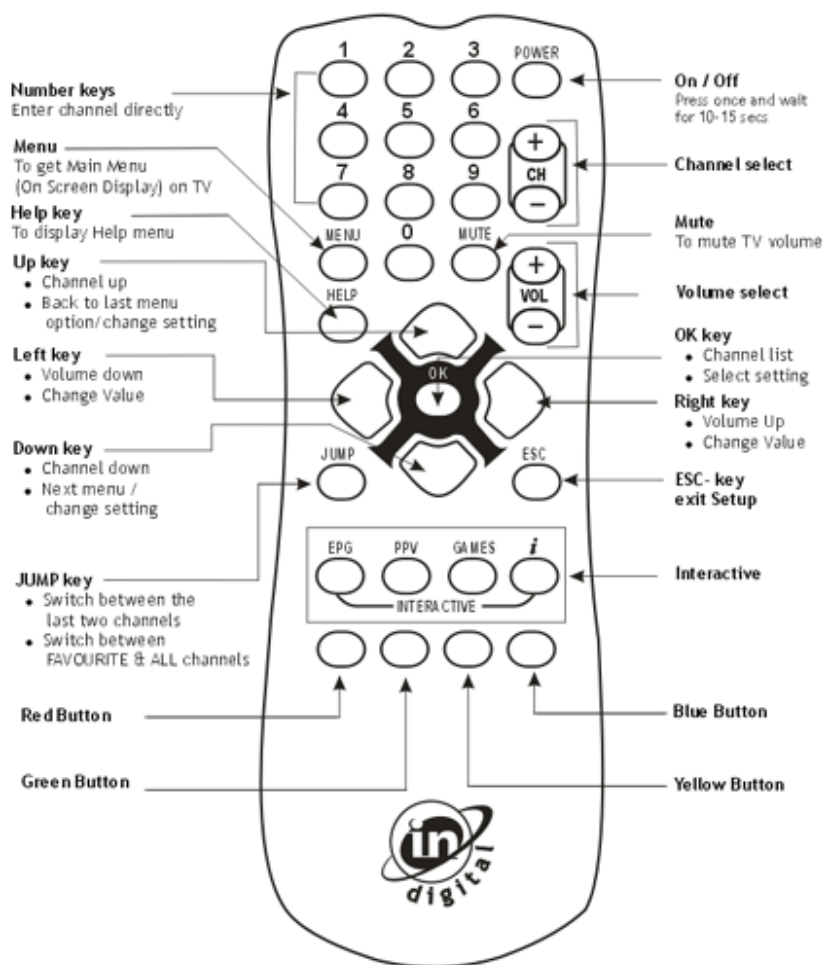

Set Top Box USER MANUAL

1.1 Front view

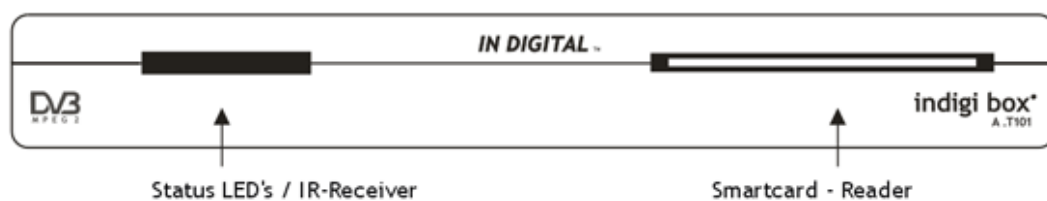

1.2 Back view

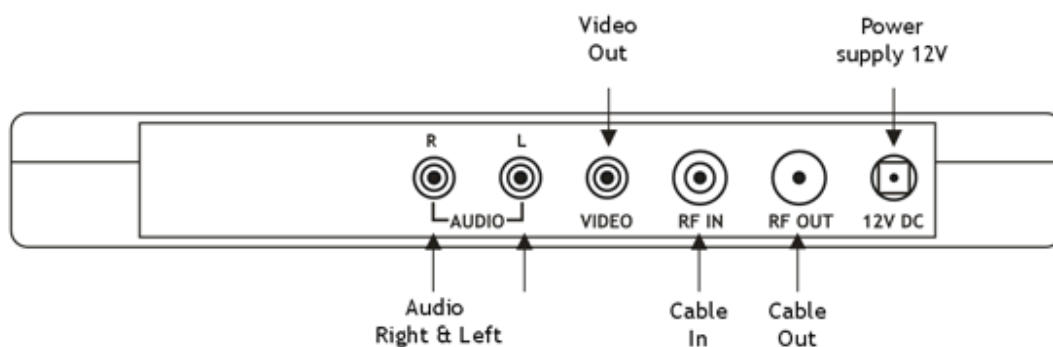

- DC IN : To 12V DC Adaptor.
- Cable IN : Connect Cable from Cable Service Provider.
- Cable OUT : Connect Cable from Digital STB to Television Set.
- Video Out : Connect Yellow Colour Jack to RCA Input (AV Input of TV).
- Audio Left and Audio Right : Connect White and Red Jack to Television Set or External Audio IN terminal of Your Music System to Listen Audio.

Set Top Box USER MANUAL

HOW DO I GET STARTED WITH DIGITAL SET TOP BOX ?

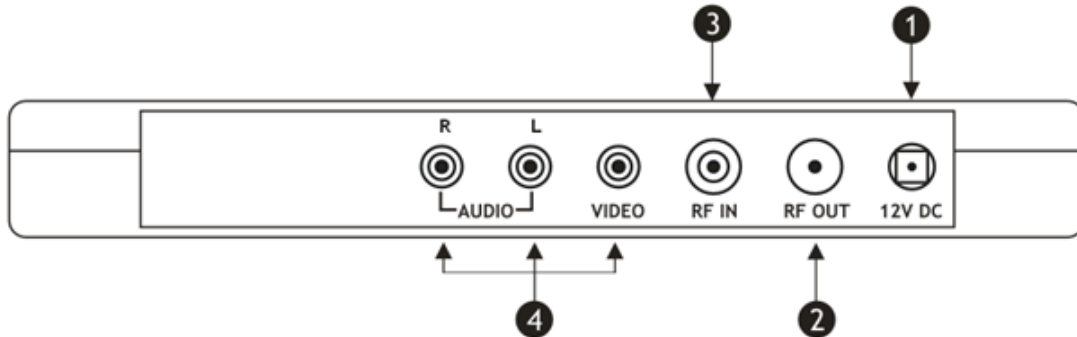

Step 1: Connect Female Connector of RF Cable provided to you, to **2** Connect the other end of cable (Male connector) to your Television Set. (The Female connector is present at the rear side of the TV).

Step 2: Connect Cable from your cable operator to **3** of your Digital Set Top Box.

Step 3: Connect A/V Cable provided to your Digital Set Top Box. The White and Red colour connectors are for Audio and the Yellow Connector is for Video. Same types of Connectors are available on your TV set. Ensure that the connectors are inserted as specified. To use the audio-video output, select AV Option of your TV.

Step 4: Connect output of 12V DC Adapter to **1** and connect other end to AC Mains.

Older models of Television sets might not have these connectors. So use connections from Step 3 only. You can use either step 3 or step 4 as a connection method.

Switch on AC Mains power for TV Set as well as Digital Set Top Box.

ATTENTION !!

Whenever the Set Top Box is turned ON by switching on the AC mains or by using the "POWER" key in the remote, the Set Top Box will take a few seconds for internal initialization.

Please wait for about 10-15 seconds before pressing any other key.

Set Top Box USER MANUAL

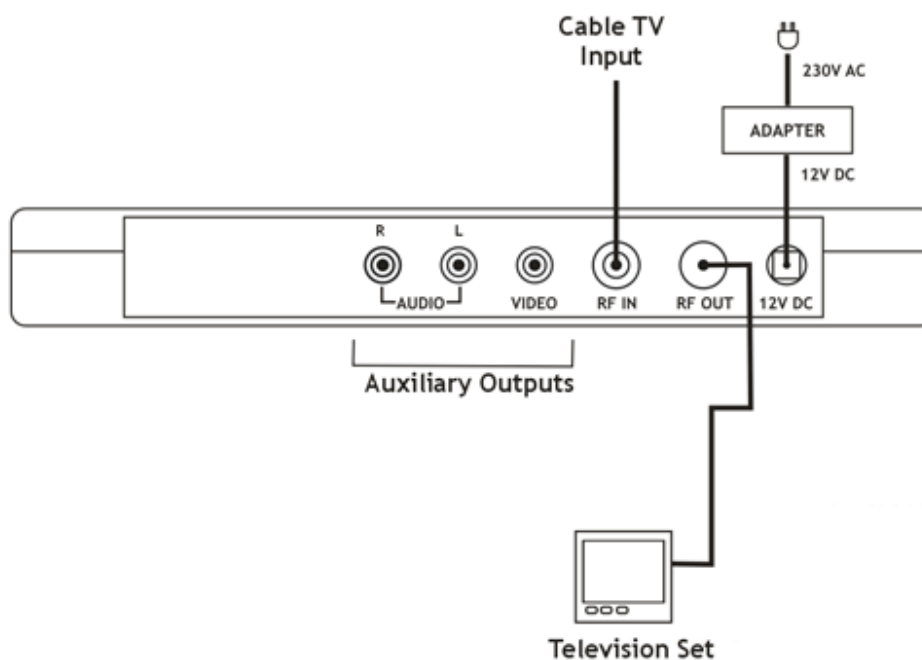

Remember:

- To tune Analog Free-To-Air (FTA) channels, use your regular television remote and the tuning menu of your Television set.
- You will need to allot any one channel on your television set to the STB output frequency to watch Pay channels (not applicable if auxiliary outputs are used).
- To tune to Digital channels, use the Set Top Box (STB) remote. It will tune both Pay & Free Digital Channels.
- The smart card needs to be inserted in the STB at all times.
- To achieve best audio quality, set the output volume of the STB to 80% and then use the volume control of the TV.
- It is normal for the STB to become warm after some time.

Set Top Box USER MANUAL

HOW DO YOU START

6.a: MENU - QUICK REFERENCE GUIDE

- Click MENU button your remote control to bring up this screen
- This screen gives you the basic information needed while navigating through the various options in the Set Top Box
- The Menu button is used to access various settings related features in your Set Top Box
- Help summons up information related to the screen currently being accessed UP/DOWN arrow buttons are used to navigate through the various options on screen. The option that is currently highlighted will have a yellow rectangle around it. Using Up/Down while watching the channel will switch to the next/previous channel
- Left/Right arrow can be used to navigate through the various options. In some options, they can be used to change the value in the option that is highlighted. Using Left/Right while watching the program will increase/decrease the volume
- OK button can be used to select the option currently highlighted or as prompted by the screen. Clicking OK while watching the channel will throw up the list of channels being broadcast on IN Digital network
- ESC can be used to escape the screen currently accessed. It takes the viewer back to the channel playing in the background
- EPG button, when clicked, throws up a screen with the various programs scheduled for that day in the channel currently being watched.
- PPV button, when clicked, takes the viewer to the PayPerView options
- Games button, when clicked takes the viewer to the Games currently available on the network
- 'i' when clicked brings up information on the current and next program being watched
- The coloured buttons viz. Red (R), Green (G), Yellow (Y) and Blue (B) correspond to on-screen functions. The exact function of these buttons will be specific to the screen being accessed and will be displayed prominently at the bottom. Pressing G while watching the program will throw up the interactive section of IN Digital's Value Added Services

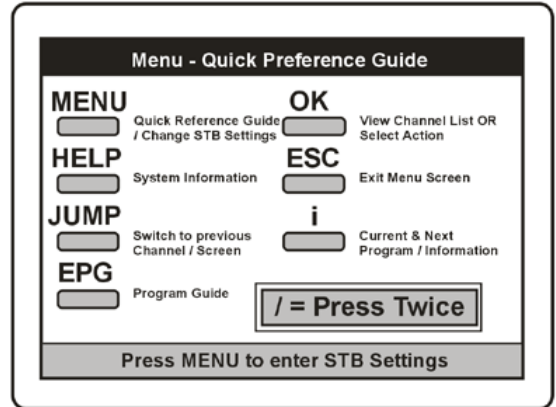

NOTE: The screens thrown up while accessing the above features are translucent and will allow the viewer to see the video in the background and also hear the audio without any disruptions. .

Set Top Box USER MANUAL

6.b: TUNING YOUR CHANNELS

- Press Menu on your Remote Control Unit and you will get the Quick - Reference Guide
- Click Menu again, and a warning message will pop up. Click OK to advance to the STB Settings Menu
- Click on the 'Lens' symbol, this is the menu for scanning channels automatically
- Press CH Scan, this will automatically scan for channels on the network
- Once this operation is complete, the channel will automatically play in the background. If this is a channel that you have not subscribed to, it will show an Access Denied error. Click ESC to close the menu and exit to the channel. Use UP/DOWN arrow keys on the Remote to navigate to another channel
- Please note that you cannot change the order in which the channels appear, like you currently do in the TV set. However, you can define a list of favourites, by going to the Favourites menu. In the favourite list, you can define the order of appearance of the channels

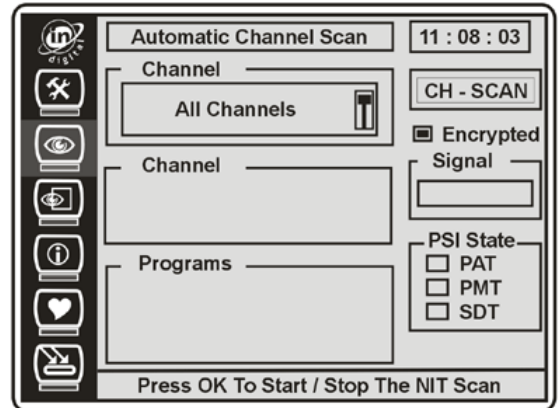

6.c: CHANGING YOUR PIN

- Access the Menu as directed in Step 2
- Click on the 'Toolkit' icon on the left side. Doing so will give you access to the Settings Menu
- Use the UP/DOWN arrow to go to the CHANGE PIN option.
- Click OK to change your PIN. The window will prompt you to enter a 4 digit PIN Code. Re-enter the code for confirmation. Use DOWN arrow to navigate.
- Click on MENU to set a lock for accessing the MENU
- Click on Channel Lock to activate Parental control for specific channels
- If Channel Lock is activated, then you will need to type the PIN each time you try to access the locked channel(s)
- Please write down and store the PIN securely

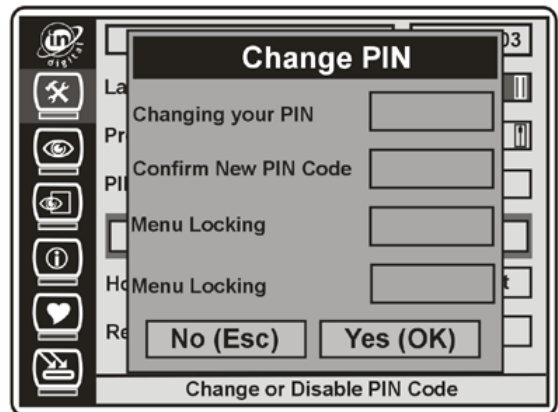

Set Top Box USER MANUAL

6.d: ADDING FAVORITES & PARENTAL LOCK

- Access the Menu as directed in Step 2
- Click on the 'Heart' symbol on the left side. This is the menu for adding and removing channels from your favourites list
- There are two columns, the left one will show the list of channels broadcast on the network. Click on the channel that you wish to add to the favourites and it will be added to the right column.
- Use UP/DOWN arrow on remote control to browse through channel list
- Use JUMP on the remote control to switch between the two columns
- The coloured buttons below correspond to four coloured buttons on your remote control unit. These buttons change their functionality depending on the type of Menu being used
- While you are in the Channel column, clicking on RED will DELETE ALL THE CHANNELS. Do not do this unless expressly required. Doing so will require you to SCAN all the channels again. Clicking on YELLOW will lock the channel. If the YELLOW button is not activated on the screen, then you will need to activate the PIN (Step IV)
- While you are in the Favourites column, clicking on RED will delete the complete list of favourite channels. Clicking on BLUE will REMOVE only the channel currently highlighted

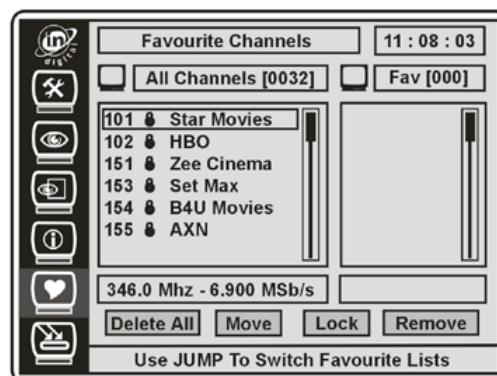

6.e: MANUAL CHANNEL SCAN

- Access the Menu as directed in Step 2
- Click on the 'Partial Lens' icon on the left side. Doing so will allow you to scan manually for channels being broadcast
- Use the UP/DOWN arrow to go to the Channel Frequency. Use the Numeric pad on your remote control to type the channel frequency
- Navigate to Symbol Rate with the DOWN arrow, use the Numeric pad to type the symbol rate manually
- Use Down arrow to go to the QAM value. Use the Left/Right arrow to set the QAM value.

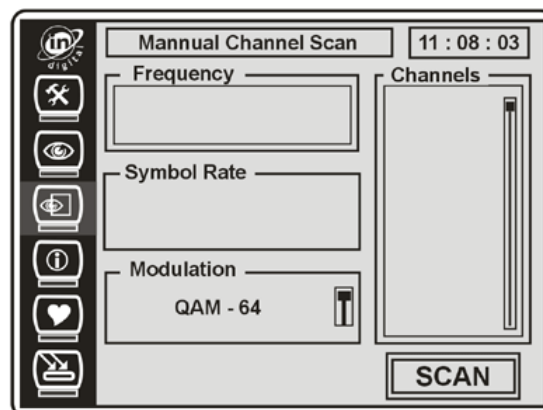

WARNING: DO NOT USE THE MANUAL SCAN OPTION UNLESS EXPLICITLY MENTIONED. THIS OPTION IS TO BE USED BY TECHNICAL PERSONNEL ONLY. If you enter this Menu and change any values accidentally, please call up the Call Centre.

Set Top Box USER MANUAL

6.f: SOFTWARE UPGRADE

- As part of its commitment to bringing the best-in-class services to its subscribers, IN Digital develops and updates the software on the STB from time to time
- This is an automated process and the subscriber does not have to make any special effort to avail of the same. The software upgrades are offered free of cost to all STB users
- The box automatically detects a new version of the software when it is available and brings up a screen that prompts the viewer to upgrade
- In case, a manual upgrade is to be done, this can be done by accessing the Software Upgrade menu Repeat Steps 1 & 2 in (II)
- Access the 'Box & Arrow' icon on the left side. This is the bottom icon in the screen
- Click on START Upgrade to begin scanning the network for a new version of the software. If a new version is detected, the box will prompt you to upgrade the version.
- Do not press any buttons while the upgrade is under progress. Once the upgrade is over, the box will restart on its own.

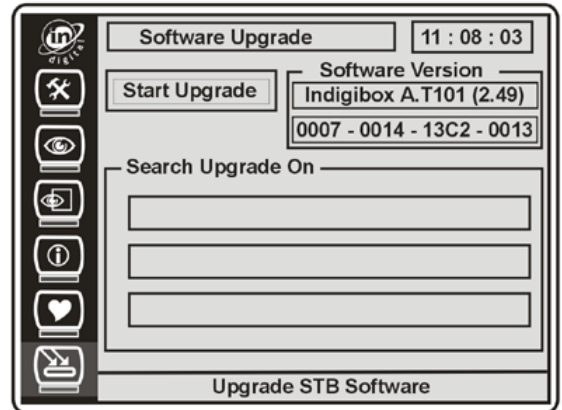

6.g: CHANNEL INFORMATION

- Access the Menu as directed in Step 2
- Select the 'i'-icon on the left side and press OK.
- This screen is non-interactive and gives you information related to the channel currently playing in the background
- Leave this menu with the ESC button.

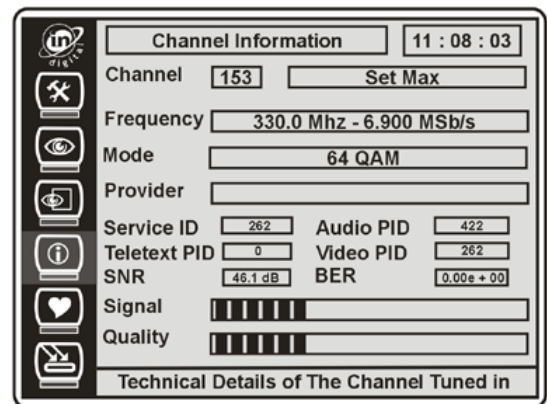

Set Top Box USER MANUAL

6.h: VIEWING CHANNEL LIST

- Click OK while watching the channel
- This will throw up a list of all the channels currently broadcast by IN Digital.
- Use the Up/Down arrow to browse through the various channels. The 'Lock' symbol next to the channel will indicate whether the channel has Parental-Lock activated on it or not
- Click OK on a channel name to view the channel directly
- Click JUMP to switch between the Favourites list and All Channel list
- Click ESC to go back to the channel.

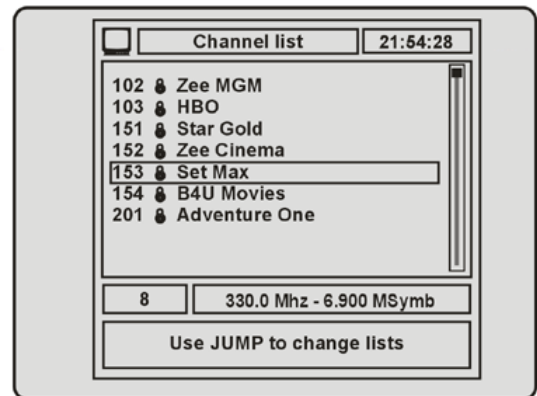

6.i: PROGRAM INFORMATION

- Click on 'i' to get information on the program that is being viewed on the channel. A window with the current program name and time, along with the next program will pop up at the bottom of the screen
- Click 'i' again to get a synopsis of the current program
- The duration of the various screens can be set by accessing the Program Info in STB Settings Screen and then using the Left/Right key to set the time duration
- Click ESC to go back to the video.

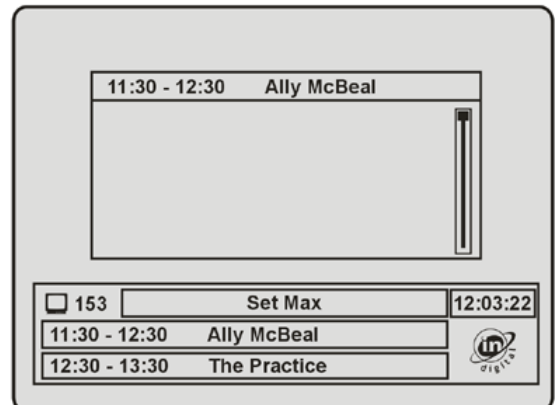

Set Top Box USER MANUAL

6.j: PLANNING YOUR ENTERTAINMENT WITH EPG

- Click on the EPG button to throw up a list of the various programs in the current channel
- Use the Up/Down arrow keys to browse through the various programs shown.
- Click OK on the program to get the program synopsis.



Set Top Box USER MANUAL

TROUBLESHOOTING

- **Why does my Digital Set Top Box not show the POWER ON indicator?**

Check that the 12V DC Adapter is properly connected to +12V DC Input of your Digital Set Top Box. Also check for AC Mains Power Switch if it is off, please switch it on.

- **Why I am not able to get Video (Picture) on my Television?**

Check to see if your Digital Set Top box is switched ON. Also check for proper connection Of cables to your Set Top Box. Ensure that Output is properly connected to the TV. If you are connected to AV then press the AV option on your TV set. If the STB is connected by RF out to the TV then you may have to scan for channels on TV with TV remote.

- **Why am I not able to see Pay Channel on my TV?**

Check with your cable operator about your subscription. Please also check if Smart Card supplied by IndusInd Media & Communications Ltd. (IMCL) is correctly inserted or not.

- **Can I hear Audio from the Set Top Box on my Music System?**

Yes. Provided that you have RCA Jacks for Audio at rear panel of your Music System.

- **Why is my Remote Control not working?**

Open the rear panel of remote control. Check if proper batteries (AA size) are inserted. If the problem persists, check to see for proper connection of batteries. If the remote control still does not work, replace the old batteries with new ones. Ensure that there is no obstacle between the STB remote control and STB unit.

Set Top Box USER MANUAL

DO's and DON'Ts

- Do not drop, knock or shake the STB or the remote. Rough handling can cause damage to the delicate electronic components.
- Do not allow any unauthorized personnel to attempt to repair or service the STB or the remote control. Any such tampering with the devices may result in serious malfunctioning.
- Do not use harsh chemicals or detergents to clean the STB. Wipe it with a soft and dry cloth.
- Do not throw/ drop your STB as you might damage it.
- Do not allow any kind of liquid to come in contact with the STB.
- Please refer to the troubleshooting tips to resolve any problems with the STB.
- Only IN Digital trained personnel are authorized to conduct repairs. Non compliance can result in the warranty being null and void.
- Please make sure that the air vents of the box are not covered by anything to avoid temperature jam in the device. We recommend about 40 cm free space on top of the STB.

In case of problems, contact your local cable operator.

Remember that the STB is your access to digital entertainment.

Treat it with care!

Set Top Box USER MANUAL

CARE & MAINTENANCE

Your digital STB and remote are advanced electronic devices which have been manufactured with precision. The STB contains decryption mechanism to allow you to watch the pay channels that you have subscribed to. Improper handling of the STB/ the remote or negligence can result in damage causing malfunction of the devices.

To ensure that you can enjoy the maximum benefits from your digital set top box and use the product for many years, follow the directions given below:

- Keep the STB and the remote out of reach of small children.
- Do not expose your STB or remote control to direct sunlight or heat.
- Keep your STB and remote in dry surroundings. Moisture may cause undue corrosion of the electronic circuits.

Please do not attempt to open the STB or the remote. Careless handling of the STB or remote may damage it and cause the warranty to be null and void.

The specifications of the STB and the actual operations may vary from the above due to continuous R&D and upgradation.